

Propellers, Nozzles, Triple and Flap Rudder Systems

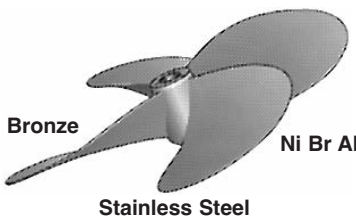

Hydrodynamic design with specially skewed propeller produces **LESS DRAG, LESS VIBRATION, and LONGER LIFE** for your nozzle!

New Rice Flap Rudder System. Decreases turning radius by 70% when compared to conventional rudders. A minimum of 5% reduction in fuel consumption. Reduced traveling time even with large loads. Typically pays for itself in two years

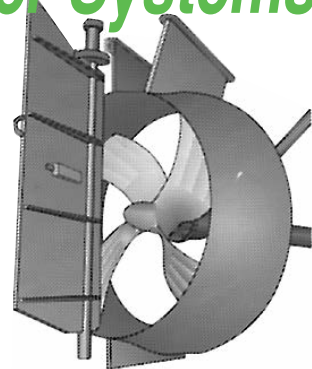

Rice Thrust Nozzles also available

8 to 13% more bollard pull

8-10% more free running speed • 8-12% fuel savings

Custom designs available



- brass
- aluminum
- stainless steel
- fixed or opening
- bolt-in or weld-in
- with / without cover
- with / without screen
- 10 to 18 inch diameters

Why not call?

PORTLIGHTS

FREEMAN QUICK-ACTING HATCHES

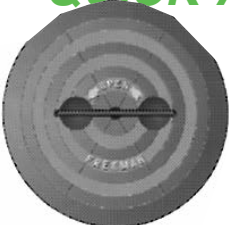

- 31 standard size covers
- custom hatches available
- flush - raised
- oval - round - square
- liftout - hinged - concealed hinge

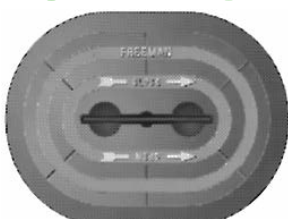

CUSTOM OPTIONS

ring type ... mechanism type ... handle style ... hinges ... escape handles...
gaskets ... finishes ... composite installations

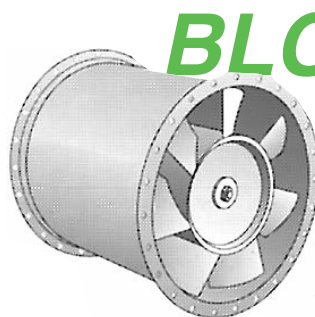

BLOWERS

MARINE TUBEAXIAL FANS MAN & PRODUCT COOLERS

- diameters from 12" to 60" (or more)
- housing gauges from .105" to .25"
- flow rates from 2380 to 224,506 cfm
- static pressure performance up to 4"

Tell us the performance you need from your next blower purchase and let us pleasantly surprise you ...first with the price and then with the quality.

Is it time

to replace your old
BUMPERS ?



FENDERING

available in almost any shape or size

SEWAGE TREATMENT

TYPE II MARINE SANITATION DEVICES

IMPROVED USCG & IMO UNITS AVAILABLE

- low maintenance
- outstanding size / performance ratio
- modular design creates flexible installation options
- non-corrosive materials
- reduced operating costs
- significant weight savings

Models range in capacity from Up To 11,160 gallons per day.

MARINE DOORS

- watertight
- weathertight
- gas/fume tight
- joiner
- quick-acting
- individually-dogged
- radius or mitred corners
- insulated - hollow - solid
- single , french, or dutch panel
- steel - aluminum - stainless steel

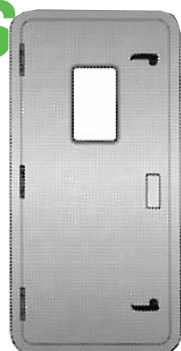

NEW!

PUMPS

Imagine at 60 PSI getting 300 GPM from a high head self-priming pump!
Available in 3-20 horsepower.
GREAT FOR FIRE & BILGE!

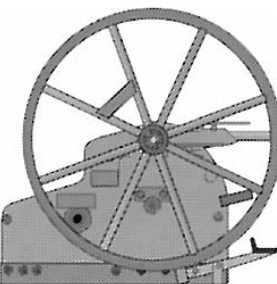
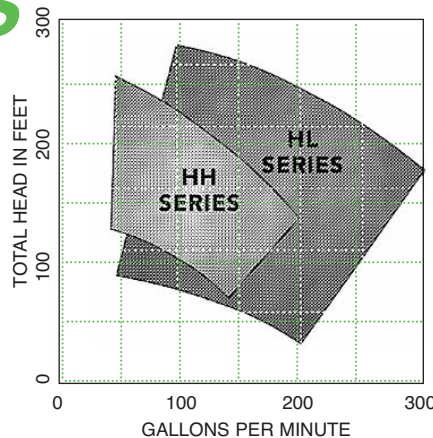

NABRICO WINCHES

- Manual
- Electric
- Hydra-Electric
- Barge moving

Why not call?

NOW INSPECTING AND SERVICING INFLATABLE LIFE RAFTS



It's just a call...

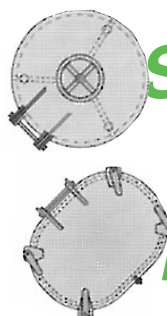

SCUTTLES DOORS HATCHES

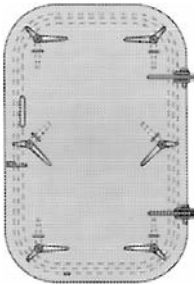

in stock & custom • standard & ABS construction
individually dogged • quick-acting

FERNSTRUM GRIDCOOLERS

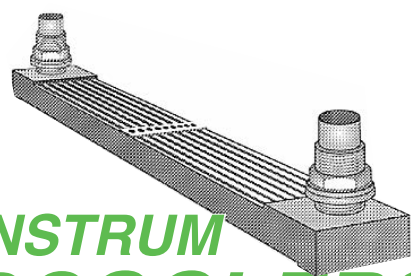

CALL FOR OUR NEW CATALOG

"WE SHIP WORLDWIDE!"

"WE SHIP WORLDWIDE!"



- | | | | | | | | | | |
|-------------------------------------------------------------------------------------------------------------------------------------|-----------------------------------------------------------------------------------------------------------|-------------------------------------------------------------------------------------------------------------------------------------------------------------------------------------------|-------------------------------------------------------------------------------------------------------------------------------------------------------|-------------------------------------------------------------------------------------------------|------------------------------------------------------------------------|---------------------------------------------------------------------------------------------------------------------|-----------------------------------------------------------------------------------------------------------------------------------------------|-------------------------------------------------------------------------------------------------------------------|-----------------------------------------------------------------------------------------------------------------------|
| HULL:
Anchors
Bumpers
Gridcoolers
Hull Anodes
Propellers
Nozzles
Shaft Bearings
DECK:
Bits | Blocks
Chocks
Doors
Gangways
Hatches
Kevels
Manholes
Scuppers
Scuttles
Winches | ENGINE ROOM
Air Compressors
Battery Boxes
Blowers
Separators
PUMPS:
Custom Packages
<i>Call us with your performance needs & we'll provide it!</i> | PLUMBING:
Sewage Treatment
Type-I MSD's
Type II MSD's
Strainers
Skimmers
Toilets
Valves
Watermakers
Water Purifiers | GALLEY:
Air Conditioners
Faucets
Freezers
Oil-free Fryers
Ovens
Ranges | Refrigerators
Sinks
QUARTERS:
Beds
Desks
Lockers | SAFETY:
Distress Signals
Dock Boxes
EPIRBS
Fire Extinguishers
Fire Nozzles
Immersion Suits | Ladders
Life Preservers
Life Rafts
Lights
Radar Transponders
PILOT HOUSE:
Clearview Screens
Compasses
Controls | Fans
Heaters
Portlights
Seating
Steering Wheels
Windows
NAVIGATION:
Airhorns
Bells | Lights
Searchlights
COATINGS
new Ceramics
new Epoxys
fire coatings
insulators
Super Therm |
|-------------------------------------------------------------------------------------------------------------------------------------|-----------------------------------------------------------------------------------------------------------|-------------------------------------------------------------------------------------------------------------------------------------------------------------------------------------------|-------------------------------------------------------------------------------------------------------------------------------------------------------|-------------------------------------------------------------------------------------------------|------------------------------------------------------------------------|---------------------------------------------------------------------------------------------------------------------|-----------------------------------------------------------------------------------------------------------------------------------------------|-------------------------------------------------------------------------------------------------------------------|-----------------------------------------------------------------------------------------------------------------------|

1-800-725-3787 • (504) 525-7137 • Fax: 504/525-6303

www.brtmarine.com